

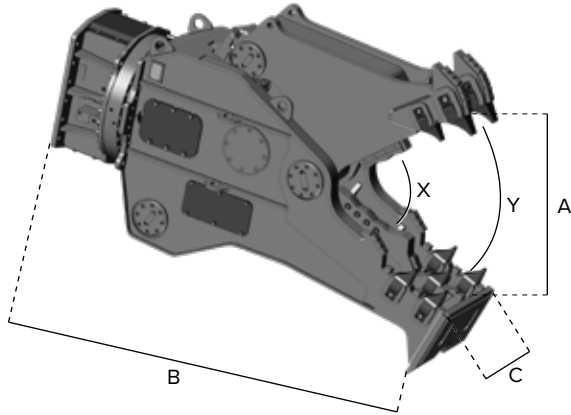







# HRP SERIES

Powerbooster Rotating Pulverizers



## POWERBOOSTER



ROTATING PULVERIZERS POWERBOOSTER			HRP-22P	HRP-27P	HRP-35P	HRP-43P
	Excavator class <sup>1</sup>	T.	16 – 21	22 – 28	29 – 35	36 – 50
	Weight	Kg.	2230	2780	3460	4300
	Cutter length	mm.	220	260	260	260
	Working pressure	Bar.	250	250	250	250
	Oil flow	L/min.	130 / 200	180 / 250	230 / 300	250/300
	Working pressure rotation	Bar.	140	140	140	140
	Oil flow rotation	L/min.	10/20	10/20	10/20	10/20
	A	mm.	755	890	950	1020
	B	mm.	2120	2450	2470	2620
	C	mm.	530	550	615	695
	X	T.	245	250	340	445
	Y	T.	90	105	120	150
	Max. Diameter	mm.	40	45	50	60

<sup>1</sup> Recommended excavator/attachement combination

